

Following these mounting instructions with the hardware included will be more than sufficient to support console installation.

Included Sink Installation Hardware

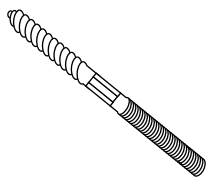

x2 hanger bolts (8mm)



x2 washer



x2 wall anchor



x2 insulation sleeve



x2 nuts

Console Installation Hardware



x1 allen wrench

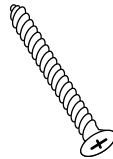

x4 1 3/4" screw

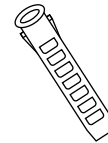

x4 wall anchor

Tools You May Need

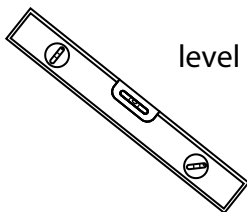

level

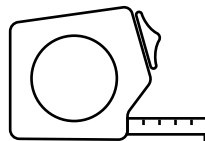

tape measure

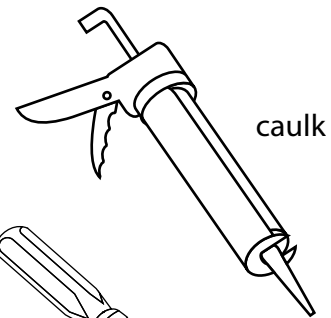

caulk

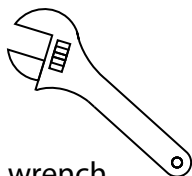

wrench

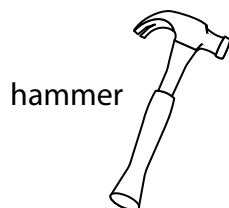

hammer

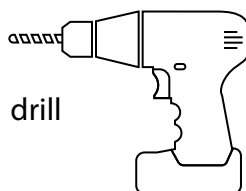

drill

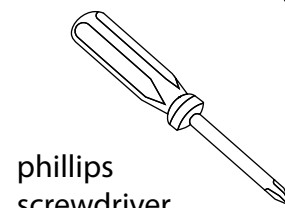

phillips screwdriver

4. Install Caulk

Finish the sink installation with a bead of caulk between the sink and wall.

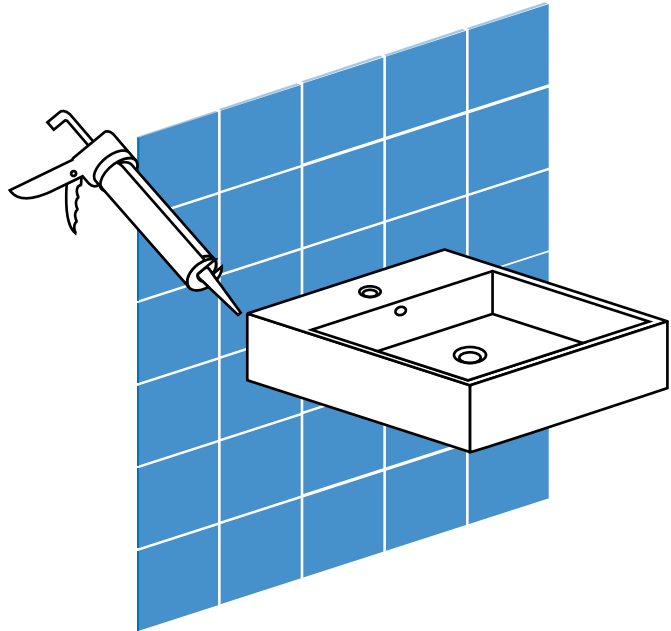

5. Assemble The Console

Assemble the console: follow these steps below.

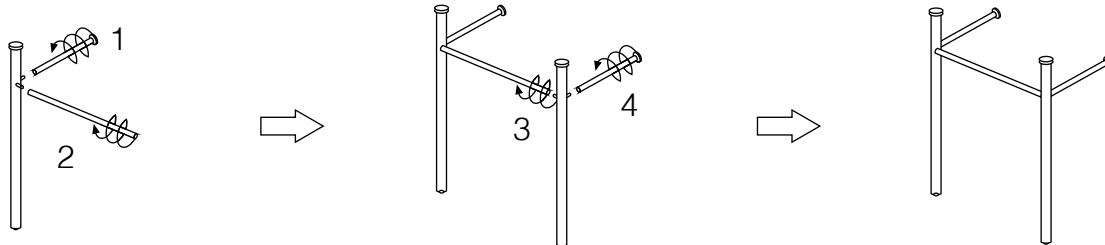

6. Mark Console Mounting Brackets

Place the console under the sink and mark the location of the brackets on the wall. Drill the holes for mounting on marked wall.

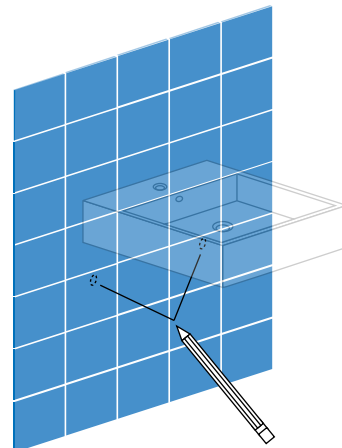

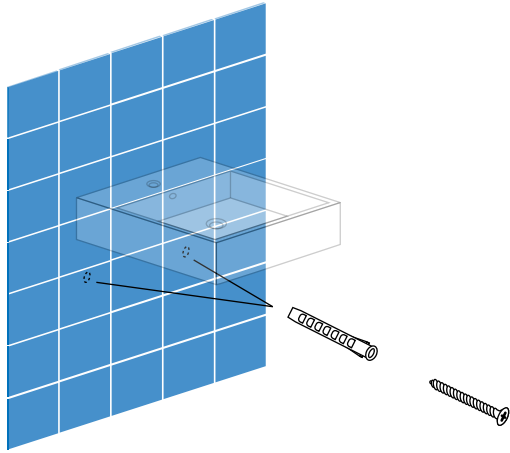

7. Mount Console Brackets

If needed, install the wall anchors. Mount the brackets with the screws included.

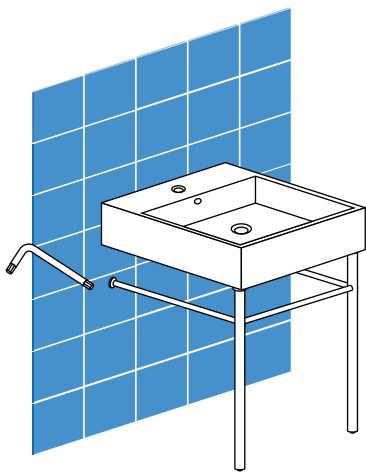

8. Mount Console Under Sink

Position the console under the sink. Mount the console to the wall bracket and tighten with included allen wrench.

9. Sink Accessories

Complete your installation by adding the preferred plumbing accessories, such as the faucet, click clack drain, p-trap and angle valves to your sink.

